



R&A Rules Limited
and
United States Golf Association

PROTOCOL FOR MEASURING THE CLUBHEAD SIZE OF
WOOD CLUBS

TPX3003
Rev. 2.1
9 April 2019

| Revision | Date | Details of Revision |
|-----------------|-------------|---|
| 1.0 | 21-Nov-2003 | Original published version. |
| 2.0 | 11-May-2018 | New major revision reflecting non device-specific testing process. Appendix added to include requirements of filling concavities on the clubhead. |
| 2.1 | 9-Apr-2019 | Updated Rules references. Reformatted step numbering and section titles to be consistent with other protocols. |

1 Scope

This protocol describes the methods used to determine the clubhead size of woods to the Equipment Rules, Part 2, Section 4b(i), as administered by R&A Rules Ltd. (The R&A) and the United States Golf Association (USGA).

2 Test Protocol - Measurement of Clubhead Volume

- a. Prior to measuring the volume, the clubhead shall be inspected for any concavities. Concavities shall be filled according to Appendix A of this document.
- b. A container shall be selected such that there is sufficient room to completely immerse a clubhead without the clubhead touching either the bottom or sides of the container. Said container shall be filled with distilled water, allowing sufficient volume to prevent spillage when the clubhead is submerged.
- c. The container shall be set upon a mass balance, and tared, Figure 2-1.
- d. If a shaft is not attached to the club, a temporary shaft or equivalent shall be used.

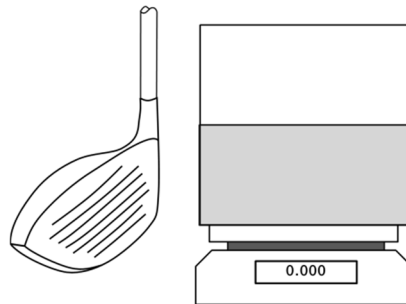

Figure 2-1: Tared electronic scale with water-filled container ready for clubhead immersion.

- e. The clubhead shall be lowered into the water until the top of the clubhead is just below the surface of the water. The hosel of the clubhead shall not be submerged, Figure 2-2.

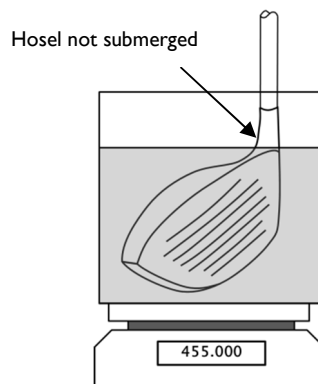

Figure 2-2: Immersed clubhead showing hosel above surface.

- f. Record the mass reported on the electronic scale, measured in or converted to grams. This is the volume of the clubhead in cubic centimeters.

3 Test Protocol - Measurement of Clubhead Dimensions

The crown plane shall be parallel to the floor plane. The toe and heel planes shall be parallel to each other, perpendicular to the floor plane, and perpendicular to the shaft axis when viewed from above. The face and back planes shall be perpendicular to the floor and toe planes. The club dimensions shall be measured with the shaft axis at 60° relative to the floor plane when viewed from the front (Figure 3-1).

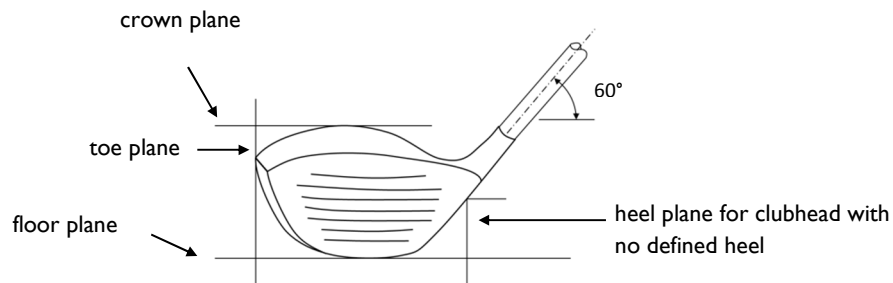

Figure 3-1: Reference frame for club head measurement. Club viewed from front.

3.1 Measurements

- a. The sole-crown dimension (height) shall be defined as the distance between parallel planes contacting the sole (floor plane) and crown (crown plane) of the clubhead (Figure 3-2).

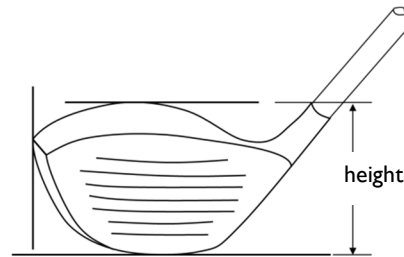

Figure 3-2: Definition of sole-crown dimension (height).

- b. The front-back dimension (depth) shall be defined as the distance between parallel planes contacting the face (face plane) at the face centre, and back (back plane) of the clubhead when viewed from above (Figure 3-3).

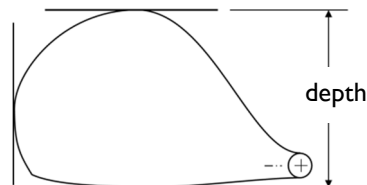

Figure 3-3: Definition of the face-back dimension (depth).

- c. If the club has a defined heel then the toe-heel dimension (length) shall be defined as the distance between parallel planes contacting the toe (toe plane) and the defined heel (heel plane) of the club. Otherwise, proceed to d.

- d. If the club does not have a defined heel, then the toe-heel dimension (length) shall be the distance between parallel planes making contact with the toe of the club (toe plane) and a point 0.875" above the sole (floor plane) of the club on the heel side (heel plane) (Figure 3-4).

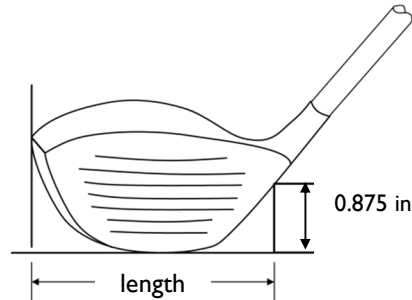

Figure 3-4: Heel-toe dimension (length) measurement for club with no clearly defined heel.

4 Determination of Conformance Status

4.1 Clubhead Volume

If the volume of the clubhead after any necessary filling is applied is greater than 460 cc plus a 10 cc tolerance (28.06 cubic inches plus 0.61 cubic inch), then the club does not conform to the Equipment Rules, Part 2, Section 4b(i) for volume.

4.2 Clubhead Dimensions

The clubhead will be found not to conform to the Equipment Rules, Part 2, Section 4b(i) for dimensions if any of the following apply:

- The sole-crown dimension (height), is greater than 2.8 inches (71.12 mm).
- The toe-heel dimension (length) is greater than 5.0 inches (127 mm).
- The front-back dimension (depth) of the clubhead is greater than the toe-heel dimension (length).

Appropriate screening methods may be applied.

Appendix A: Method for inspection and filling of concavities

- a. All concavities on the crown (excluding concavity created by the existence of a hosel) shall be filled with waterproof clay or equivalent material using a straight-line method that connects the edges of the cavity. The straight-line method does not follow the taper or curvature of the surface of the head, rather the cavity is filled so that it becomes a surface that adjoins the outer edges, Figure A-1.
 - i. Where there are multiple peaks surrounding a concavity, straight lines shall be drawn that maximize the included volume.
 - ii. If the included volume of a concavity is affected by the choice of which edges are connected by the straight line, then the edges that maximize the included volume will be used.
- b. Significant concavities elsewhere on the head shall likewise be filled. The definition of significant concavities is any single concavity with a volume of greater than 15 cc or, if the sole has more than one concavity, the collective volume of these is greater than 15 cc.
- c. The volume of the clubhead shall be measured to include all features on the clubhead excluding the hosel but including filled concavities.

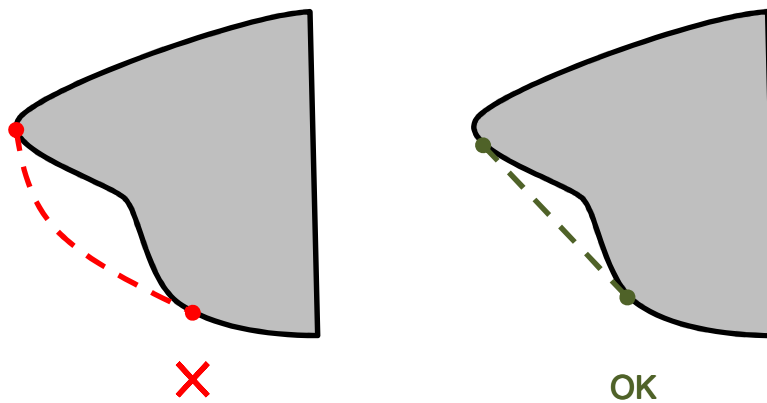

Figure A-1: Profile generated by half cross-section of a clubhead to be filled, showing improper following of taper or curvature (left), and correct method (right).